

# L'essenziale che arreda

ART. 489 - Dosatore per sapone in ottone cromato



ART. 490 - SOFIA - sifone per lavabo



ART. 494 - SOFIA - sifone per lavabo quadro

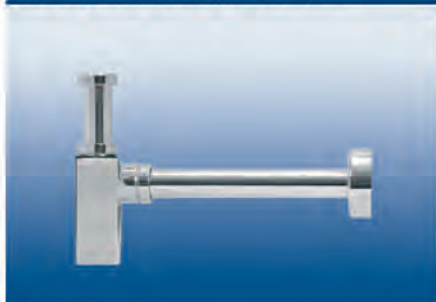

ART. 495 - Troppo pieno per lavabo in ottone cromato



ART. 499 - GRACE - sifone per lavabo/bidet



ART. 496 - Golf IN & OUT - piletta per lavabo/bidet



## *FASHION*

*LINEA ARREDOBAGNO*

## GHIDINI

Ghidini S.p.A., via case nuove n.4  
Rodengo Saiano (BS), Italia  
Tel. +39 0306810760 - Fax. +39 0306810902  
[www.ghidini-sifoni.com](http://www.ghidini-sifoni.com) - [info@ghidini-sifoni.com](mailto:info@ghidini-sifoni.com)

Dopo quarant'anni di esperienza Ghidini S.p.a. presenta la nuova linea arredobagno Fashion, una sintesi di stile e funzionalità per soddisfare le esigenze estetiche attuali. Prodotti tipicamente minimalisti dal design moderno ed elegante vestiranno il tuo bagno di nuove emozioni.

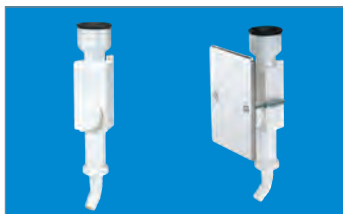

LAVATRICE					
CODICE	MINIMO VENDITA	DESCRIZIONE	MISURA	CODICE FORNITORE	€
0129750°	1	<b>105</b> - Sifone incasso lavatrice in PP mod. Polo con codolo PVC, con coppella di protezione, piastra ABS bianca	40 x 40	105	8,055
0130330°	1	come sopra, piastra Inox	40 x 40	105I	8,627
0130391	1	<b>107</b> - Sifone incasso lavatrice in PP mod. Polo con codolo PEHD, con coppella di protezione, piastra ABS bianca	40 x 40	107	8,055
0130360	1	come sopra, piastra Inox	40 x 40	107I	8,627
0130327°	1	<b>115</b> - Sifone incasso lavatrice in PEHD mod. Cobra con coppella di protezione, piastra ABS bianca, CERTIFICATO DIN EN 274	40 x 40/50	11550	13,342
0129749°	1		40 x 40	115	13,110
0130326°	1	come sopra, piastra Inox	40 x 40/50	11550I	13,883
0130325°	1		40 x 40	115I	13,636
0130185°	20	<b>400</b> - T a 90° in PP con attacco lavatrice	40 x 1 1/2 H 230	4002340	5,705
0130175°	20	<b>402</b> - Tubo con battente e ghiera in PP con attacco lavatrice	40 x 1 1/2 H 200	40240112	7,158
0130154°	10	<b>2364</b> - Raccordo completo per sifone lavatrice	1	2364P	2,782
CONDENSA					
0130323°	1	<b>120</b> - Sifone per scarico condensa esterno	1" x 46	120	8,503
0130324°	1	<b>121</b> - Sifone per scarico condensa ad incasso con placca inox	1" x 46	121	9,106
LAVELLO					
0130304°	1	<b>125</b> - Sifone a tubo in PP, per lavelli a una via mod. 2000 CERTIFICATO DIN EN 411	1 1/2" x 40	12511240	9,353
0130303	1		1 1/2" x 50	12511250	9,693

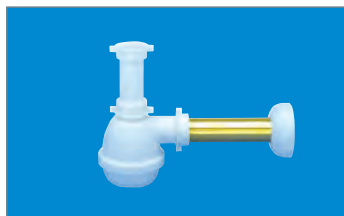

LAVELLO					
CODICE	MINIMO VENDITA	DESCRIZIONE	MISURA	CODICE FORNITORE	€
0130308°	1	<b>126</b> - Sifone a tubo in PP, per lavelli a una via con attacco lavatrice mod. 2000 CERTIFICATO DIN EN 411	1 1/2" x 40	12611240	10,188
0130307	1		1 1/2" x 50	12611250	10,528
0130312°	1	<b>150</b> - Sifone Universal a una via, tubo ottone	1 1/2" x 40	1500	16,666
0130321°	1	come sopra, tubo PP	1 1/2" x 40	150P	16,001
0130331°	1	<b>155</b> - Sifone Universal a due vie, tubo ottone	1 1/2" x 40	1550	23,175
0130318	1	<b>156</b> - come sopra, a tre vie	1 1/2" x 40	1560	30,333
0130319°	1	<b>155</b> - Sifone Universal a due vie, tubo PP	1 1/2" x 40	155P	22,510
0130317	1	<b>156</b> - come sopra, a tre vie	1 1/2" x 40	156P	29,669
0130384°	1	<b>285</b> - Sifone Globo a una via, senza piletta, tubo ottone cm 25	1 1/2" x 40	2850	10,497
0130372°	1	come sopra, tubo PP	1 1/2" x 40	285P	7,823
0130376°	1	<b>305</b> - Sifone Globo a due vie, con pilette Ø 80, tubo ottone cm 25	1 1/2" x 40	3050	14,254
0130375°	1	come sopra, tubo PP	1 1/2" x 40	305P	11,580
0130149°	5	<b>1625</b> - Curva filettata con ghiera, in polipropilene, per Globo e Continental cm. 23	Ø 40 1 1/2"	162523	3,834
0130313°	1	<b>310</b> - Sifone Euro a una via, attacco lavatrice, con piletta Ø 80, tubo ottone cm 25	1 1/4" x 32	3101140	12,786
0130232°	1	come sopra, tubo PP	1 1/4" x 32	310114P	10,235
0130361°	1	<b>312</b> - Sifone Euro a due vie, attacco lavatrice, con piletta Ø 80, tubo ottone cm 25	1 1/4" x 32	3121140	18,320
0130371°	1	come sopra, tubo PP	1 1/4" x 32	312114P	15,769

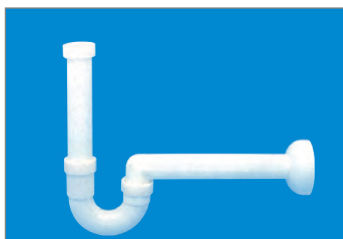
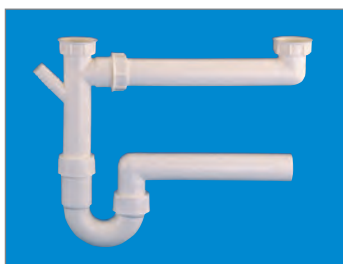

LAVELLO					
CODICE	MINIMO VENDITA	DESCRIZIONE	MISURA	CODICE FORNITORE	€
0130277°	1	141 - Sifone a tubo in PP per lavelli a due vie, con attacco lavatrice, mod. 2000 CERTIFICATO DIN EN 411	1 1/2" x 40	14111240	13,342
0130276	1		1 1/2" x 50	14111250	13,729
0130156°	10	1615 - Prolunga "Lillo" con ghiera, in polipropilene, cm. 20	Ø 40 1 1/2"	1615	4,854
0130336°	1	329 - Piletta gattinara filettata, per lavello	1 1/4" x 80	32911480	5,024
0130337°	1		1 1/2" x 80	329112	6,586
0130338	1	come sopra, per lavabo	1 1/4" x 65	32911465	4,792
0130125°	1	331 - Piletta gattinara per lavello inox	1 1/2" x 70	331112	7,158
0130124°	1	332 - Piletta gattinara con troppo pieno per lavello inox	1 1/2" x 70	332112	10,018
0130211°	1	333 - Piletta con cestello estraibile per lavelli con foro 3 1/2" con vitone mm 40	1 1/2" x 115	333112	23,036
0130090°	1	334 - Piletta con cestello estraibile, con troppo pieno, per lavelli con foro 3 1/2" con vitone mm 40	1 1/2" x 115	334112	27,906
0130111°	10	1705 - Cestello asportabile per art. 333-334		1705	12,878
LAVABO/BIDET					
0130283°	1	340 - Sifone Tipo per lavabo	1 1/4"-1" x 40	340	9,353
0130284°	1	350 - Sifone Tipo per bidet, Ø 40 cm 30	1 1/4"-1" x 40	350	9,353



DOCCIA						
CODICE	MINIMO VENDITA	DESCRIZIONE	MISURA	CODICE FORNITORE	€	
0130351	1	360 - Piletta doccia con sifone snodato PEHD Ø 40/50 mm	Ø 70	36070	23,036	
0130339°	1		Ø 80	36080	23,036	
0130110°	1	2000 - Cestello in ottone cromato con OR gomma per art. 360 - 365 - 369 - 623		2000	7,251	
0130347	1	365 - Piletta doccia con sifone snodato PP con raccordo filettato 1 1/2" Ø 40 mm	Ø 70	36570	23,654	
0129741°	1		Ø 80	36580	23,654	
0129745°	1	367 - Piletta doccia griglia piana, con sifone snodato PP con raccordo filettato 1 1/2" Ø 40 mm, griglia inox	1 1/2"	36780I	16,666	
0130346	1		come sopra, griglia ottone	1 1/2"	367800	22,696
0130332°	1	369 - Piletta doccia sifonata con coperchio ABS cromato, con uscita orientabile Ø 40/50 mm, con curva orientabile	40/50 x 80	36980	25,649	
0130341°	1		40/50 x 115	369115	28,942	
0130344°	1	come sopra, senza curva	40/50 x 80	36980S	23,654	
0130343°	1		40/50 x 115	369115S	26,932	
PAVIMENTO						
0130335°	1	379 - Piletta pavimento in PEHD con sifone fisso Ø 40/50 mm	100 x100	379	30,086	
VASCA						
0130320°	1	387 - Colonna vasca scarico automatico normale, in plastica	1 1/2" x 70	387	54,730	
0130350	1		come sopra, a sedere	1 1/2" x 70	387S	55,411
0130322°	1		come sopra, con erogazione	1 1/2" x 70	387E	128,800
0130112°	1	389 - Sifone vasca fisso in PEHD Ø 40/50 MM	1 1/2" x 40/50	389	11,533	
0130128°	1	395 - Sifone vasca snodato in PP con raccordo filettato 1 1/2" Ø 40 mm, dado ottone	1 1/2" x 40	395112	13,157	
0130113	1		come sopra, dado PP	1 1/2" x 40	395112P	12,708
0130083°	20	2377 - Dado ottone cromato	1	23771	1,205	
0130081°	10		1 1/4	2377114	1,716	

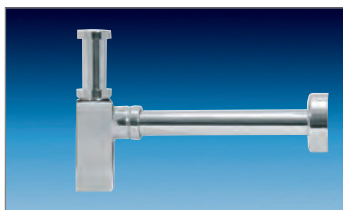
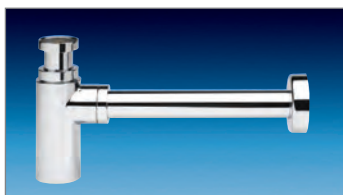

## LAVATRICE

CODICE	MINIMO VENDITA	DESCRIZIONE	MISURA	CODICE FORNITORE	€
0129917°	2	422 - Sifone lavatrice esterno mod. Rapido	32 x 40	422	15,414

## LAVELLO

0129990°	2	465 - Piletta Simplex senza dado e codolo	1 1/4" x 80	46580114	8,008
0129992°	2		1 1/2" x 80	46580112	8,132
0130016°	2	come sopra, per lavabo	1" x 65	465651	7,065
0129991°	2		1 1/4" x 65	46565114	7,467
0130014	2	480 - Pilettoni sifoide con troppo pieno e con codolo diritto, gabbietta inox	1 1/4" x 77	480CL	23,871
0130012°	2		come sopra, senza dado e codolo	1 1/4" x 77	480CLS

## BIDET E LAVABO

## MODELLO SOFIA

0129934°	1	490 - Sifone per lavabo mod. Sofia, tubo 25 cm	1 1/4"	490114	81,168
0129947°	1	494 - Sifone per lavabo mod. Sofia quadro, tubo 25 cm	1 1/4"	494114	105,500
0129935°	1	come sopra. tubo cm 30	1 1/4"	49411430	108,300

## MODELLO GHIDINI

0129985°	1	515 - Sifone bottiglia senza piletta mod. Ghidini, tubo cm 25	1" x 26	515125	24,690
0129984°	1		1 1/4" x 32	51511425	34,059
0129918°	1	540 - Sifone a S, mod. Ghidini, tubo cm 25	1" x 26	540125	24,690
0129946°	1		1 1/4" x 32	54011425	34,059
0129921°	1	550 - Sifone per lavabo a colonna, mod. Ghidini, tubo 25 cm	1" x 26	550125	24,690
0129920°	1		1 1/4" x 32	55011425	34,059

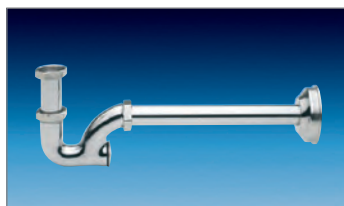
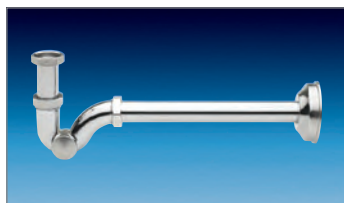

## BIDET E LAVABO

## MODELLO CONCORD

CODICE	MINIMO VENDITA	DESCRIZIONE	MISURA	CODICE FORNITORE	€
0129956°	1	529 - Sifone bottiglia senza piletta, mod. Concord, tubo cm 20 CERTIFICATO DIN 19545	1 " x 26	5291	16,218
0129958°	1		1 1/4" x 32	529114	21,985
0129747°	1	come sopra, tubo cm 25	1 " x 26	529125	16,481
0129742°	1		1 1/4" x 32	52911425	22,263
0129910°	1	541 - Sifone a S, mod. Concord, tubo cm 20	1 " x 26	5411	16,218
0129936°	1		1 1/4" x 32	541114	21,985
0129748°	1	come sopra, tubo cm 25	1 " x 26	541125	16,481
0129916°	1		1 1/4" x 32	54111425	22,263
0129924°	1	551 - Sifone per lavabo a colonna, mod. Concord, tubo 20 cm	1 " x 26	5511	16,218
0129923°	1		1 1/4" x 32	551114	21,985
0129746°	1	come sopra, tubo cm 25	1 " x 26	551125	16,481
0129922°	1		1 1/4" x 32	55111425	22,263

## MODELLO 2000

0129744°	1	539 - Sifone a S mod. 2000, tubo cm 25	1 1/4" x 32	53911425	13,877
0129743°	1	549 - Sifone per lavabo a colonna, mod. 2000, tubo 25 cm	1 1/4" x 32	54911425	13,877
0129913°	1	554 - Sifone Molecola	1 " x 26	5541	26,886
0129911°	1		1 1/4" x 32	554114	36,502

## BIDET E LAVABO

0130029°	1	496 - Piletta per lavabo/bidet con troppo pieno Mod. Golf "In & Out"	1 1/4" x 63/H 60	496114	55,102
0130057°	1		come sopra, senza troppo pieno	1 1/4" x 63/H 60	496114STP

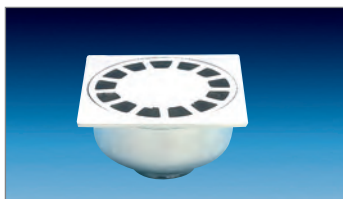

## BIDET E LAVABO

CODICE	MINIMO VENDITA	DESCRIZIONE	MISURA	CODICE FORNITORE	€
0130059°	2	565 - Piletta lavabo con troppo pieno	1" x 58/H 70	5651S	9,369
0130066°	2		1" x 58/H 85	565851S	10,992
0130038°	2		1 1/4" x 64/H 65	565114S	12,090
0130063°	2	come sopra, senza troppo pieno	1" x 58/H 70	5701S	9,369
0130062°	2		1 1/4" x 64/H 65	570114S	12,090
0130064°	2	575 - Piletta lavabo scarico libero, con troppopieno	1 1/4" x 65	575114	20,361
0129802°	1	576 - Scarico automatico	1 1/4" x 63	576114	25,262

## DOCCIA

0130053	1	623 - Piletta sifoide per doccia, pesante, con dado e codolo	H 70 x Ø 70	6237070	33,998
0130052°	1		H 70 x Ø 80	6237080	33,998
0130018	1	come sopra, senza dado e codolo	H 70 x Ø 70	6237070S	30,333
0130067°	1		H 70 x Ø 80	6237080S	30,333

## PAVIMENTO

0130056°	1	650 - Pilettone pavimento griglia quadra con scarico diritto, attacco filettato 1 1/4"	100 x 100	650P100	30,132
0130055	1		150 x 150	650P150	52,241
0130205	1	Griglia		2355100	7,111
0130048°	2	654 - Pilettone pavimento griglia quadra con scarico curvo, attacco filettato 1 1/4"	100 x 100	654P100	41,372
0130058	1		150 x 150	654P150	71,907
0130205	1	Griglia		2355100	7,111
0129801°	3	721 - Sifone a pavimento con griglia quadrata e imbuto a caduta	100 x 100	721	43,398
0130093°	1			Griglia e imbuto per art. 721	172690
0129800	1	720 - Sifone a pavimento con griglia tonda e imbuto a caduta	Ø 90	720	33,240
0130094°	1			Griglia e imbuto per art. 720	1726720



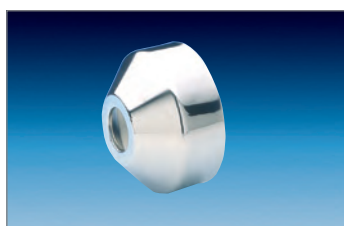
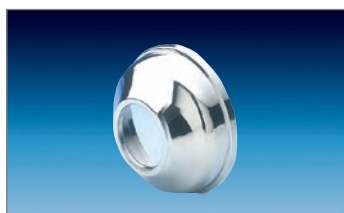

VASCA					
CODICE	MINIMO VENDITA	DESCRIZIONE	MISURA	CODICE FORNITORE	€
0130023°	1	760 - Piletta vasca senza sifone	1 1/4" x 70	760114N	21,706
VARI					
0129826°	10	821 - Prolunga in ottone mm. 50	1 " x 50	8211	10,590
0129814	8		1 1/4" x 50	821114	12,090
0129751°	15	824 - Riduzione in ottone	F1 1/2" M1 1/4"	8240112	6,168
0129759°	15		F1 1/4" M1 "	8240114	6,045
0129761°	50		come sopra, in PP	F1 1/2" M1 1/4"	824M112
0129762°	100	825 - Riduzione in PP	F1 1/4" M1 1/2"	825M114	0,664
0129763°	100		F1 " M1 1/4"	825M1	0,618
0129758	100	836 - Rosone ottone cromato	Ø 21	83621	0,664
0129781°	50		Ø 26	83626	1,762
0129780°	50		Ø 30	83630	1,762
0129779°	50		Ø 32	83632	1,762
0129778	50		come sopra, foro ovale	Ø 30	836300V
0129757	1	836E - Rosone conico in ottone cromato per tubo eccentrico	Ø 26	836E26	8,627
0129756	50		Ø 30	836E30	8,627
0129766°	50		Ø 32	836E32	8,627
0129755	50		come sopra, foro ovale	Ø 30	836E300V
0129754°	50	839 - Rosone inox	Ø 26	83926	1,020
0129753°	50		Ø 30	83930	1,020
0129752°	50		Ø 32	83932	1,020
0129775	50		Ø 40	83940	1,066
0129777	50		come sopra, foro ovale	Ø 30	839300V
0129767	50	Rosone in PP	Ø 32	839P32	0,463
0129776	50		Ø 40	839P40	0,479
0129786	50		Ø 50	839P50	0,494
0129852°	10	840 - Tubo pieghevole	300 x Ø 26	8403026	9,369
0129851°	10		300 x Ø 30	8403030	9,894
0129850°	10		300 x Ø 32	8403032	10,327



VARI					
CODICE	MINIMO VENDITA	DESCRIZIONE	MISURA	CODICE FORNITORE	€
0129813°	10	841 - Prolunga telescopica con or gomma	130 x Ø 26	8411426	3,648
0129812°	10		130 x Ø 30	8411430	3,803
0129782°	10		130 x Ø 32	8411432	3,957
0129842	10	842 - Tubo curvo	250 x Ø 32	8422532	7,884
0129841	50	843 - Tubo eccentrico, con rosone come sopra, senza rosone	300 x Ø 26	84326	21,660
0129840	50		300 x Ø 30	84330	21,907
0129839	50		300 x Ø 32	84332	22,170
0129838	50		300 x Ø 26	843S26	13,033
0129827°	50		300 x Ø 30	843S30	13,296
0129836°	50		300 x Ø 32	843S32	13,543
0129900	1	844 - Tubo con battente, ottone cromato come sopra, polipropilene	75 x Ø 26	8447526	1,963
0129893	1		75 x Ø 32	8447532	2,164
0129903°	1		200 x Ø 26	8442026	3,602
0129899	1		200 x Ø 30	8442030	3,849
0129907°	5		200 x Ø 32	8442032	3,957
0129892	1		200 x Ø 40	8442040	6,740
0129902°	5		250 x Ø 26	8442526	4,158
0129887	5		250 x Ø 30	8442530	4,468
0129895°	5		250 x Ø 32	8442532	4,545
0129891	1		250 x Ø 40	8442540	7,807
0129901°	5		300 x Ø 26	8443026	5,967
0129897°	5		300 x Ø 30	8443030	6,246
0129894°	5		300 x Ø 32	8443032	6,307
0129890	1		300 x Ø 40	8443040	8,874
0129857	1	100 x Ø 40	844P1040	0,803	
0129889	1	200 x Ø 32	844P2032	1,082	
0129906	1	200 x Ø 40	844P2040	1,236	
0129831	1	850 - Tubo in ottone cromato come sopra, in ottone giallo	200 x Ø 26	8502026	3,262
0129835	1		200 x Ø 30	8502030	3,525
0129863°	5		200 x Ø 32	8502032	3,525
0129859	1		200 x Ø 40	8502040	6,307
0129830°	5		250 x Ø 26	8502526	3,803
0129837°	5		250 x Ø 30	8502530	4,205
0129862°	5		250 x Ø 32	8502532	4,205
0129858	1		250 x Ø 40	8502540	7,312
0129829°	5		300 x Ø 26	8503026	5,612
0129865°	5		300 x Ø 30	8503030	5,967
0129861°	5		300 x Ø 32	8503032	5,967
0129847°	5		300 x Ø 40	8503040	8,395
0129855	1		800 x Ø 26	8508026	12,414
0129864	1		800 x Ø 30	8508030	13,852
0129860°	1		800 x Ø 32	8508032	13,852
0129856	1		800 x Ø 40	8508040	21,567
0129854	1		100 x Ø 40	850G1040	2,628
0129866	1		250 x Ø 32	850G2532	3,633
0129853	1		250 x Ø 40	850G2540	6,029